

ACCESSORIES CATALOG

2026



Options and accessories



AVADY CONNECT COMMUNICATION KIT

Treat, monitor, and analyze your pond with ease!

- The AvadyConnect® communication kit allows remote control and management of water treatment equipment parameters for easy pool management, via the dedicated web interface www.avadyconnect.com.
- The kit consists of two elements:
 - A device to be connected to the Ethernet network, enabling radio communication (AvadyConnect® option)
 - An extension to be installed in the device to enable communication with the AvadyConnect® option
- Compatible products : PROpilot pH® Rx (1,5l/h) / PROpilot pH® Rx (3l/h) /DUO pH® Rx (1,5-1,5l/h) / DUO pH Turboxy (1,5L/h-3L/h) / Panneaux sauf PANmagnet

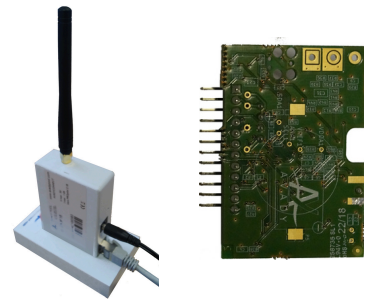

Model	Reference
Option Kit Avady Connect®	AYAC100524

Remote control and operation:

- Water regulation; pH, Chlorine,
- Low level of treatment products,*
- Temperature*,
- Operation of the filtration pump and booster pump*,
- Lighting*,
- Condition of equipment: shutters*,
- Email alert, advice.

* Depending on the connected device.

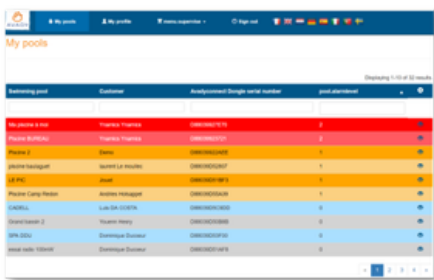

List of park basins

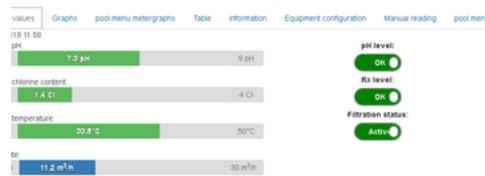

One glance is enough:
Parameters in the green =
Peaceful swimming!



Explore the interface using the username and password "demo".

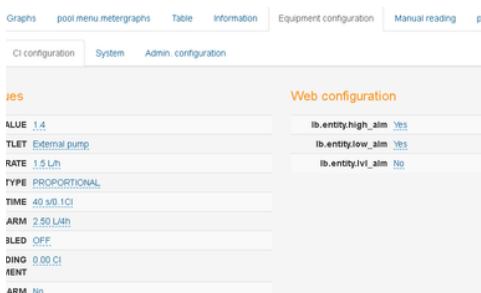

pH and chlorine settings can be changed remotely



Historical data

2-IN-1 PROBE HOLDER

Make installing your device easier!

- A single point for measurement and injection.
- The probe is 100% protected by the tube of the probe holder.
- A winterizing plug replaces the probe in the Probe Holder.
- Fits diameters of 50 and 63.
- Horizontal or vertical installation.

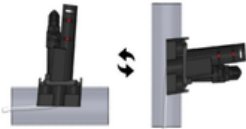

AVADY EXCLUSIVE

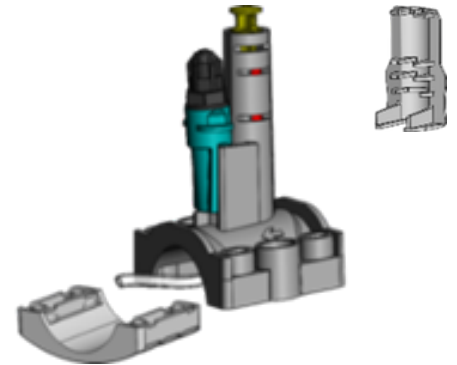

Model	Reference
2-in-1 Probe Holder	AYFA00011

CRISTALSTOP® INJECTOR

Make installing your device easier!

- Suitable for the 2-in-1 Probe Holder.
- Delays crystal formation at the chlorine injection point.
- Increases the lifespan of the peristaltic pump.

AVADY EXCLUSIVE



Model	Reference
CRISTALstop® injector	AYFA00006
Kit de maintenance CRISTALstop® (x3)	AYAC100502



Scan or click to discover our accessories!

CLIP'EASY

Clip and Swim !

- Quick and easy installation thanks to a drilling guide
- Horizontal or vertical series mounting
- Less material = more eco-friendly
- No screws, no bolts = no rust, a clean and durable finish
- Probe protected for better longevity



Model	Reference
Clip'Easy	AYAC100827
Probe sealing kit	AYAC100482
Clip'Easy probe holder	AYACAC0006

INJECTION VALVE

Limit crystallization!

- Direct installation in the pipeline
- Optimal sealing thanks to an O-ring
- Reducing the risk of chlorine crystallization
- Included in several Avady device kits (PRIM, TEMPO UV, STAR...)
- A patented solution, designed to save time and improve performance on every intervention.

AVADY EXCLUSIVE



Model	Reference
Injector	AYACAC0004



Scan or click to discover our accessories!

TURBOXY® PROBE

The multi-function probe!

- Unique amperometric probe capable of being installed directly on pipes.
- Chlorine reading in ppm.
- Stabilizer tolerance up to 40 ppm.
- Very easy to maintain.

AVADY EXCLUSIVE



Grand Prix Innovation
Lyon 2016

Model	Reference
Turboxy® Amperometric Probe	AYAC08F00

TURBOXY® OFFSET TUBE KIT

Make installing your device easier!

- Facilitates the installation of the Turboxy probe and allows for installation in DN63.
- Allows control of the speed of water passing through the Turboxy probe.
- This kit is highly recommended for optimal use of the Turboxy® probe. It helps correct many problems such as insufficient flow, pressure loss, or lack of space in the pipe.

AVADY EXCLUSIVE



Model	Reference
Turboxy® offset tube kit	10000020

TURBOXY® PH AND CHLORINE PROBE ANALYSIS CHAMBER

The multi-function probe!

- Allows for better management of the Turboxy® probe.
- Allows sampling to be taken as close as possible to the probes.

* Probes not included

AVADY EXCLUSIVE

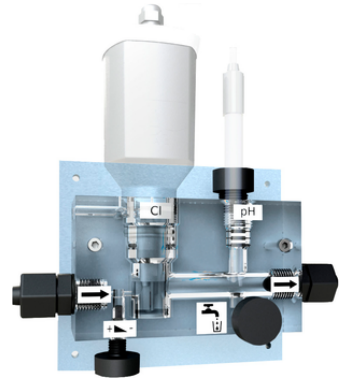

Model	Reference
Turboxy® analysis chamber and its complete kit	AYAC100474

ANALYSIS CHAMBER FOR PH AND REDOX PROBES

Simplify your sampling process!

- Allows sampling to be taken as close as possible to the probes.

* Probes not included

AVADY EXCLUSIVE



Model	Reference
pH Rx analysis chamber	AYAC100473



Scan or click to discover our accessories!

SPRING KIT

Our Spring Kit will be your best ally for restarting your pool. Combined with our tutorial videos, calibrating your technical installations will be easy!

Save time when restarting your pool

- Practical video user guide
- Compatible with all types of automatic water treatment equipment
- Ready-to-use kit, simplified dosing thanks to our single-dose solutions

Model	Reference
Spring Countertop POS Display Kit, set of 20	MARKET0004
pH Kit Spring Refill POS Display	AYAC100870



WINTER KIT

Our Winterizing Kit will be your best ally for a stress-free winterization of your pool. Combined with our tutorial videos, winterizing your technical installations will be a breeze!

Protect your equipment with proper winter storage

- Practical video user guide
- Compatible with all types of automatic water treatment equipment
- Facilitating the restart in the spring
- Ready-to-use kit, simplified dosing thanks to our single-dose solutions
- Complete kit: cleaning solution, storage solution, brush, electrode cap, winterizing cap

Model	Reference
Winterizing Kit for Countertop POS Displays, Pack of 20	MARKET0005
pH Winterizing Kit Refill POS Display	AYAC100871



Scan or click to discover our accessories!

MAINTENANCE KIT

Our Maintenance Kit will be your best ally for maintaining your Avady dosing equipment. Combined with our tutorial videos, your technical interventions will be made easier!

Save time when maintaining your appliances: ready-to-use kit

- Preserve the lifespan of technical installations
- Compatible with the entire Avady dosing range
- Practical video user guide
- Complete kit: transparent cover, roller holder kit, peristaltic tube, grease tube



Model	Reference
Countertop POS Display Maintenance Kit, pack of 20	MARKET0003
pH Kit Maintenance Recharge PLV	AYAC100869



Scan or click to discover our accessories!

PROBES



Model	Reference
1. pH probe, 80mm long - 3m cable	AYAC08AG01
1. pH probe, 120mm long - 3m cable	AYAC08AG00
2. Rx Probe Length 80mm - 3m Cable	AYAC08BD01
2. Rx Probe Length 120mm - 3m Cable	AYAC08BD00
2. Gold Rx Probe, 120mm Length - 3m Cable	AYAC08BD05
3. Turboxy® Amperometric Probe and Installation Kit	AYAC08F00
4. CLM M12 Probe for Organic/Inorganic Free Chlorine with Cable	AYAC08DG7
4. CLM M12 Probe for Organic/Inorganic Free Chlorine without cable	AYAC08DG6
4. Cable for CLM M12 probe 0.7M	AYAC100670



Scan or click to discover our accessories!

PROBE MAINTENANCE



Model	Reference
1. pH/Rx probe cleaning solution 60mL	AYACSOLNET03
2. Solution de stockage sonde pH/Rx 60mL	SENS008184
3. pH7 standard solution 20mL - batch of 26	ACCE007119-PDC
4. pH4 standard solution 20mL - batch of 26	ACCE007122-PDC
5. Standard solution 475mV 20mL - batch of 26	ACCE007124-PDC
6. Fresh and saline gel for CLM probe	AYAC09AA0002
7. Membrane for CLM probe free organic/inorganic chlorine	AYAC09AA0001
8. Turboxy® B10 Abrasive Maintenance Kit	10000019



Scan or click to discover our accessories!

ACCESSORIES



Model	Reference
1. Santoprene 6*9mm peristaltic tube (1.5L/h and 3L/h)	AYAC100152
1. Santoprene peristaltic tube 7*3mm (0.5L/h)	AYAC100179
1. Tube Cristalsil 6,3*9,5mm - longueur 140mm (1,5L/h)	AYAC100479
2. 1/2" - 4*6 injection valve (peristaltic pump)	AYACAC0004
3. Magnet adapter valve for 2-in-1 probe holder injector	AYAC100285
4. 1/2" and 3/8" injection valve - 4x6 and 10x14 (electromagnetic pump)	AYACAC0003
5. Complete probe holder for standard collar	AYACAC0005
6. Complete probe holder for Clip'Easy and panels	AYACAC0006
7. Foot strainer for Magnet pump	AYAC100005
8. Foot strainer for peristaltic pump	AYAC100020
9. Washable filter cartridge for panels	AYAC100541
10. Kit of 5 foam inserts for quick-connect protective filter	AYAC100638
11. Complete 2-15L/h PVDF pump body	AYAC100036
Hydraulic kit (roller holder + peristaltic tube + cover)	AYAC100165

TUBES



Model	Reference
1. Tube PVC Cristal 10*14 (10m)	AYAC100204
2. 10*14 polyethylene tube (10m)	AYAC100129
1. Tube PVC Cristal 4*6 (25m)	AYAC100018
2. 4*6 polyethylene tube (25m)	AYAC100016
3. 8*10 polyethylene pipe (25m) for panel connection	AYAC100644
2. 10*14 polyethylene tube (50m)	AYAC100037
1. Tube PVC Cristal 10*14 (50m)	AYAC100017



Scan or click to discover our accessories!

TANKS, CONTAINERS, SUCTION TUBES



Model	Reference
1. Polyethylene tank I 50L	AYAC03A007
1. 100L polyethylene tank	AYAC03A002
1. Polyethylene tank I 200L	AYAC03A003
1. 300L polyethylene tank	AYAC03A004
1. Polyethylene tank I 500L	AYAC03A005
1. Polyethylene tank I 1000L	AYAC03A006
2. Safety tray for 60 and 100L tanks	AYAC04A001
2. Safety tray for 200L tank	AYAC04A002
2. Safety tray for 300 and 500L tanks	AYAC04A004
2. Safety tray for 1000L tank	AYAC04A005
3. 4x6 H50 Suction Tube with Jack Plug	AYAC100353
3. 4x6 H80 Suction Tube with Jack Plug	AYAC100503
3. 4x6 H50 suction wand with 4-pole plug	AYAC100298
3. Suction wand 4x6 H80 with 4-pole plug	AYAC100501
3. Suction wand 4x6 H50 length 4m wire end	AYAC100358

General Terms and Conditions of Sale



GENERAL TERMS AND CONDITIONS OF SALE

Article 1 - Warning

In order to improve the quality of its products, the company POOL TECHNOLOGIE (hereinafter "POOL TECHNOLOGIE") reserves the right to modify, at any time and without notice, the characteristics of its products.

The sketches, photos, texts, and illustrations appearing in the catalogs, as well as all other communication materials, are provided for informational purposes only and are not contractually binding. Any reproduction or representation, even partial, by any means whatsoever, of the pages published in the printed and electronic catalogs or on the POOL TECHNOLOGIE website, without the written authorization of POOL TECHNOLOGIE, is illegal and constitutes copyright infringement.

Article 2 – General Provisions

These general terms and conditions of sale apply to the business relationship between POOL TECHNOLOGIE and professional resellers, hereinafter referred to as "the Client" or "the Clients." They do not apply in any way to contractual relationships between resellers and their customers or end users. The Client and POOL TECHNOLOGIE mutually acknowledge each other as professionals in the products sold by POOL TECHNOLOGIE (hereinafter "Products").

These General Terms and Conditions of Sale (GTC) are available on the POOL TECHNOLOGIE website (<https://pool-technologie.com>), in the catalog, and can be sent to the Customer upon request to enable them to place an order. Consequently, placing an order implies the Customer's full and unreserved acceptance of these GTC, to the exclusion of all other documents, including their own general terms and conditions of purchase. No special conditions may prevail over these GTC unless expressly agreed to in writing by POOL TECHNOLOGIE beforehand. Any conflicting condition stipulated by the Customer, unless expressly accepted by POOL TECHNOLOGIE, will therefore be unenforceable against POOL TECHNOLOGIE regardless of when it was brought to its attention. The Customer accepts that POOL TECHNOLOGIE may subsequently and reasonably modify these GTC and that their relationship will always be governed by the latest terms and conditions in effect on the date of the order.

This version of the Terms and Conditions cancels and replaces previous versions.

Article 3 – Orders

3-1 No one may claim tacit agreement from POOL TECHNOLOGIE. All Customer orders must be placed in writing (email, letter) and must specify the desired delivery address, billing address, order number, order date, product references, quantity, and specifications. An order containing incomplete or incorrect information may result in errors or delays for which POOL TECHNOLOGIE cannot be held responsible.

3-2 Unless otherwise stipulated, offers and quotes from POOL TECHNOLOGIE are valid only for one month following their issuance. In this case, the contract is formed only upon the Client's unreserved acceptance of the terms and conditions set forth in the quote. In practice, the Client expresses their consent by returning the signed quote by email or mail, or by placing an order that expressly references the quote.

3-3 An order is only valid after acceptance by POOL TECHNOLOGIE, which is evidenced by the issuance of an order acceptance acknowledgement. If the Customer does not contest the order acceptance acknowledgement in writing within 48 hours of its issuance, the order becomes final.

GENERAL TERMS AND CONDITIONS OF SALE

3-4 Any order placed with POOL TECHNOLOGIE and accepted by the latter under the aforementioned conditions becomes contractual and cannot be modified or cancelled without the prior agreement of POOL TECHNOLOGIE. In the event of a request to cancel the contract formed (hereinafter "Contract") by the Client more than 48 hours after the issuance of the order acceptance acknowledgment, POOL TECHNOLOGIE reserves the right to invoice for the raw materials and labor already committed to fulfilling said Contract, without prejudice to its right to claim any damages.

3-5 The benefit of the Contract is personal to the Client and may not be assigned in any way without the prior written consent of POOL TECHNOLOGIE.

Article 4 – Price

4-1 The unit prices quoted are in Euros, excluding VAT, and are ex-works (EXW, 2010) from the POOL TECHNOLOGIE warehouses. Prices are subject to revision without notice, particularly due to currency fluctuations or any other factor that may affect the price of raw materials or labor. POOL TECHNOLOGIE will inform the Customer of any such changes. The revised prices will then apply to the Customer's future orders.

ECO-PARTICIPATION: Prices are exclusive of eco-participation. In France, a flat-rate contribution is applied to the unit selling price upon invoicing. As the eco-participation is not a tax, VAT is applied to this contribution.

4-2 All orders may be subject to a deposit, the amount of which varies depending on the Products, before manufacturing and/or delivery. The applicable deposit amount is specified in the Contract. Delivery of the Products is contingent upon full payment of this deposit. The remaining balance must be paid in accordance with the following terms and conditions.

Article 5 – Payments

Invoices are payable in full, without discount, to the address indicated on the invoice. For ongoing business relationships and with the agreement of POOL TECHNOLOGIE's credit insurer, invoices are payable, without discount, by L.C.R. (bill of exchange) submitted directly for collection, without prior acceptance, and within 30 days end of month from the invoice date. In the event of refusal of the invoice, deliveries will only be made with payment before delivery or cash on delivery. POOL TECHNOLOGIE reserves the right, in the event of a deterioration in the Client's creditworthiness based on objective data, to adjust the applicable payment terms, set a limit on its outstanding balance, and/or require payment guarantees or payment before shipment. After simple notification by registered letter with acknowledgment of receipt, POOL TECHNOLOGIE may suspend or cancel the execution of current orders, refuse new ones or demand cash payment.

GENERAL TERMS AND CONDITIONS OF SALE

Article 6 – Acceleration of the term – Late payment penalties

6-1 In the event of failure to pay on any of the due dates, all of POOL TECHNOLOGIE's claims against the Client will become due and payable by operation of law without prior formal notice procedure.

6-2 If the Customer has not fulfilled its obligations, POOL TECHNOLOGIE may then validly refuse to sell, unless the Customer provides satisfactory guarantees or a collectable payment before delivery of the Products.

6-3 Any delay in payment beyond the due date shall automatically result in a late payment penalty equivalent to three (3) times the legal interest rate.

6-4 Any payment delay beyond the due date will automatically and without further formality incur a fixed penalty of €40. When recovery costs exceed €40, POOL TECHNOLOGIE reserves the right to claim additional compensation from the debtor, upon presentation of supporting documentation. In the event of late payment resulting in legal action, the Client will owe fixed compensation equal to 20% of the Product price, in addition to all recovery costs incurred.

Article 7 – Costs and delivery times

7-1. Costs Unless otherwise stipulated, products, excluding export sales, are delivered to the Customer according to the Incoterm (ICC 2020) EXW POOL TECHNOLOGIE factory, unless otherwise expressly agreed. Therefore, if POOL TECHNOLOGIE arranges transport to the location specified in the Contract, it does so solely as the Customer's agent. Transport costs are invoiced separately to the Customer. In the case of "cash on delivery," the collection fees charged by the carrier are the responsibility of the Customer.

Export sales are carried out according to the FCA incoterm, place of loading, which stipulates that the formalities and costs of customs clearance are the responsibility of the Seller, while the Buyer bears the cost of transport, with the Products being made available at the Seller's premises where the loading takes place.

7-2. Delivery times Delivery times are always given as an indication only, without guarantee and any delays cannot give rise to damages, withholding or cancellation of orders in progress or refusal of Products.

	Landi ng	Delivery to professionals	Direct home delivery	Delivery to a collection point
Orders under €750	1	21,00 €	+6 €	+3 €
Orders under €1,499 excluding VAT.	2	26,00 €	+6 €	+3 €
Orders exceeding €1,499 excluding VAT.	3	37,00 €	+6 €	+3 €
OVERSIZED ITEMS > 30 kg or pallet	CONTACT US			

GENERAL TERMS AND CONDITIONS OF SALE

Article 8 – Retention of Title

IN ACCORDANCE WITH LEGAL PROVISIONS, THE TRANSFER OF OWNERSHIP OF THE DELIVERED PRODUCTS ONLY TAKES PLACE ON THE DAY OF FULL PAYMENT OF THE PRICE OF SAID PRODUCTS; REGARDLESS OF THE DELIVERY AND PAYMENT CONDITIONS, however, the risks are transferred to the Customer as soon as the Products are made available to him, to one of his agents or to the carrier.

a. Product Identification and Separation: The Client is responsible for ensuring the identification and separation of the Products, preventing their unpacking or merging into a common inventory. In the event of receivership or liquidation proceedings, the Client undertakes to have the administrator, receiver, or creditors' representative prepare a complete list of the Products belonging to POOL TECHNOLOGIE.

b. Claim: In the event of non-payment by the Client, without losing any of its rights, POOL TECHNOLOGIE may demand, by registered letter with acknowledgment of receipt, the return of the goods at the Client's expense and risk.

c. Reorganization and judicial liquidation: The Client undertakes to keep POOL TECHNOLOGIE informed of any change in its situation, and in particular of its declaration of cessation of payments.

Article 9 – Transfer of Risk, Acceptance and Claims

From the date of delivery, as stipulated in Article 7, the products travel at the customer's own risk. Pool Technology strongly recommends that the customer obtain insurance coverage for risks related to the transport of the products or consult Pool Technology if they wish Pool Technology to arrange this for them.

In the event of a dispute during delivery by the carrier, it is the recipient's responsibility to:

a. To note on the carrier's delivery receipt, after unpacking the Product, the dispute observed (e.g. missing package, broken package, wet package...) and to detail as much as possible the damage suffered by the Product, it being understood that any mention "subject to unpacking" will not be enforceable against POOL TECHNOLOGIE.

b. To confirm to the carrier, in accordance with Article L.133-3 of the Commercial Code and within the time limits provided for therein, the reservations taken on the receipt, by registered letter with acknowledgment of receipt, a copy of which is sent to POOL TECHNOLOGIE.

c. To send as soon as possible to POOL TECHNOLOGIE a copy of the signed delivery receipt as well as a copy of the registered letter addressed to the carrier.

WARNING: No claim will be accepted if the three points above have not been scrupulously respected.

Article 10 – Return of new equipment

POOL TECHNOLOGIE is not obligated to accept the return of a Product for reasons beyond its control. Unless otherwise specified and without the prior written consent of POOL TECHNOLOGIE, no Product returns will be accepted.

In any event, the return of a Product, once the return has been accepted by POOL TECHNOLOGIE, must:

a. Be completed within eight days of acceptance by POOL TECHNOLOGIE, b. Be a product listed in POOL TECHNOLOGIE's professional catalog, valid at the time of return, c. Have been the subject of a Return Merchandise Authorization (RMA) request, d. Have been the subject of prior written agreement from POOL TECHNOLOGIE, e. Be accompanied by the RMA authorization, f. Be sent prepaid in the original packaging

The product returned under the conditions described above will systematically be subject to a discount of 15% with a minimum flat fee of €50.

GENERAL TERMS AND CONDITIONS OF SALE

IMPORTANT: Failure to comply with the conditions specified above will result in either the return being refused or the product being returned with a 30% discount on the invoiced price. Furthermore, after technical inspection, an additional discount may be applied in the case of an incomplete or damaged product. In the event of a return due to an ordering error by the customer, the initial shipping costs remain the customer's responsibility.

Article 11 – Warranty

The Products marketed by POOL TECHNOLOGIE comply with the required technical specifications as well as (i) the legislation in force in the European Union for European models and (ii) the legislation in force in the United States of America and Canada for North American models.

Certain Products manufactured and marketed by POOL TECHNOLOGIE are subject to a contractual warranty for a period starting from the date of delivery of the Products as defined in Article 7 of the General Terms and Conditions of Sale, a period which varies depending on the Product range as defined at the following address: <https://pool-technologie.com/nos-garanties-equipements-materiels-pool-technologie/>

In this case, POOL TECHNOLOGIE guarantees the conformity of the Products to the Contract under the following conditions and limits.

Without prejudice to the exclusions applicable to each Product, the warranty does not apply in the event of a defect or fault arising from:

- use of the Products not in accordance with the technical instructions accompanying the Products, or not in accordance with any requirements of POOL TECHNOLOGIE or with any uses, laws and regulations in force;
- of any installation, maintenance and, in general, of any interventions not carried out exclusively by professionals with proven expertise in the field;
- of any installation, maintenance and, in general, of any interventions not carried out in accordance with the standards in force in the country of installation at the time of installation;
- the use of accessories and/or options not from POOL TECHNOLOGIE (e.g., ORP or amperometric pH probe, cell, sensors, pool earth, cables, etc.)
- modifications to the Product specifications imposed by the Customer, unforeseen events or force majeure,
- normal wear and tear of the Products;
- negligence, particularly in the storage of the Products,
- any repairs, alterations, interventions or modifications carried out on the Products without the prior written consent of POOL TECHNOLOGIE,
- the defect in the implementation of the process of using the Products or the defect in the maintenance of the Products.

The electrolysis cells will not be replaced under warranty if:

- They show obvious signs of use and are scaled up.
- The catalytic coating has been damaged, notably by mechanical scraping
- They were used without an adequate water flow
- They were used in cold water < 15°C
- They were used in water lacking salt
- They have been used in water with excessive levels of metals (particularly in borehole water). For dosing devices, the following components are considered wear parts: Santoprene of the pump, pump drive rollers, tubing, injector.

The use of multiacids (pH-) containing hydrochloric acid voids the product warranty.

Electronic boxes will not be covered under warranty if they are exposed to an excessively corrosive environment, particularly due to the presence of unvented containers of acids (pH-) or liquid chlorine nearby (see installation instructions for the device). Insufficient tightening of the electrical cell cable terminals may result in electrical damage which is not covered under warranty.

Any potential defect must be reported to POOL TECHNOLOGIE within 8 days of its discovery, by means of a written notification sent by registered letter with acknowledgment of receipt. The Client must allow POOL TECHNOLOGIE every opportunity to inspect and remedy these defects.

GENERAL TERMS AND CONDITIONS OF SALE

The warranty covers the repair, by POOL TECHNOLOGIE and its workshops, of manufacturing and material defects. Removal, reinstallation, and transport costs are excluded from the warranty.

In all cases, POOL TECHNOLOGIE's responsibility is limited to the replacement of defective parts without any compensation or damages being claimed for material or bodily injury or other harm caused.

IMPORTANT: The Customer is hereby informed and expressly acknowledges that technical instructions, user manuals, installation and maintenance guides, and more generally any documentation relating to the use of the Products may be provided to the Customer and/or users of the Products electronically. If necessary, the user may request a printed copy of the documentation from POOL TECHNOLOGIE.

IMPORTANT: Replacement of parts under warranty shall in no way extend the originally granted warranty period.

Spare parts availability: After the end of marketing of a Product or a commercial range of Products, the availability of spare parts is equal to the duration of the initial contractual warranty.

Article 12 – Liability and Insurance

POOL TECHNOLOGIE and the Client mutually acknowledge themselves as professionals in the products sold. The Client recognizes POOL TECHNOLOGIE as a supplier of equipment to be integrated by the Client into a comprehensive functional system. The Client, in their capacity as a pool professional, remains responsible for the choice of Product, its integration method, and its proper use according to the instructions in the user manual provided with the Product, in accordance with best practices, the regulations in force in the country of installation at the time of installation, and the desired outcome. Under no circumstances does POOL TECHNOLOGIE have any obligation regarding the final result; all of POOL TECHNOLOGIE's obligations are understood to be obligations of means. Any claim by the Customer relating to the performance of a sale against POOL TECHNOLOGIE, regardless of its cause or nature, for the calendar year, must be notified to POOL TECHNOLOGIE by registered letter with acknowledgment of receipt no later than twelve (12) months following the alleged non-performance of its obligations by POOL TECHNOLOGIE. After this period, and notwithstanding the provisions of Article L110-4 of the French Commercial Code, no claim for the calendar year may be raised by the Customer against POOL TECHNOLOGIE, which the Customer expressly acknowledges and accepts. The parties acknowledge that POOL TECHNOLOGIE may always preclude any liability claim by replacing or bringing into conformity a non-conforming Product. In any event, except in cases of gross negligence or willful misconduct, Pool Technology's liability is limited to the replacement, repair, exchange for a new or refurbished product, or refund of the disputed products. As such, Pool Technology's liability shall not exceed the amount paid by the customer for the products. Pool Technology shall under no circumstances be liable for any intangible and/or indirect damages, including but not limited to loss of profits, loss of customers, loss of revenue, loss of data, moral or commercial damages, or damage to brand image that the customer may suffer.

Article 13 – Force Majeure

The parties' contractual obligations are suspended in the event of force majeure. In the event of such an occurrence, the parties shall endeavor in good faith to take all reasonably possible measures to continue the performance of the Contract. If the force majeure event lasts for more than sixty (60) days, the Contract may be terminated by either party, without either party being entitled to compensation. The following are contractually considered force majeure and constitute grounds for the termination or suspension of POOL TECHNOLOGIE's obligations, without recourse for the Client: accidents affecting the production and storage of products, total or partial interruption of supply, carrier failure, fire, flood, machinery breakdown, total or partial strike, cyberattacks, administrative decisions, actions of third parties, war, or any external event that may delay, prevent, or render the performance of the commitments made economically prohibitive.

GENERAL TERMS AND CONDITIONS OF SALE

Article 14 - Termination

POOL TECHNOLOGIE has the right to terminate the Contract automatically, by registered letter with acknowledgment of receipt, in the event of total or partial non-performance of its obligations by the Client, including its payment obligation, respect for intellectual property rights, and more generally, the good faith performance of the Contract, thirty (30) days after a formal notice sent by registered letter with acknowledgment of receipt has remained unheeded and must include a declaration by POOL TECHNOLOGIE of its intention to invoke this clause, without prejudice to compensation for any direct and indirect damages that this termination may cause. If, due to the nature of the unfulfilled obligation, it is not possible for the defaulting party to remedy it, the Contract may be terminated automatically by either party without notice, and the Contract will end upon receipt of the letter notifying the termination. POOL TECHNOLOGIE will not owe any compensation to the Client.

Article 15 – Intellectual and Industrial Property

15-1 Unless expressly stipulated otherwise in the contract, the contract does not entail any transfer whatsoever of the intellectual property rights attached to the Products, trademarks, logos, databases, texts, graphics, images, audio files, videos, and any other element protected by intellectual property rights to the Client. POOL TECHNOLOGIE retains ownership of the related intellectual property rights. Similarly, all plans, documents and technical data, instructions, samples, or any other document provided to the Client by POOL TECHNOLOGIE in the performance of the contract, as well as, where applicable, the related intellectual property rights, remain the exclusive property of POOL TECHNOLOGIE. Nothing herein shall be interpreted as constituting an assignment, transfer, sale, grant, license, loan, lease, or authorization to use said intellectual property rights, whether granted directly or indirectly by POOL TECHNOLOGIE to the Client. Consequently, by paying the price stipulated in the contract, the Client acquires only a right to use the results of the Products protected under POOL TECHNOLOGIE's intellectual property rights. For any other use, the Client must contact POOL TECHNOLOGIE to define the terms, including financial terms. The Client agrees not to infringe, directly or indirectly, or through any third parties with whom it is associated, the intellectual property rights of POOL TECHNOLOGIE. The Client warrants that all elements provided to POOL TECHNOLOGIE, if any, in connection with the creation of the Products do not infringe the intellectual property rights of third parties. The Client shall indemnify POOL TECHNOLOGIE against any and all consequences of any kind (including legal fees, attorney's fees, damages, and compensation) in the event that POOL TECHNOLOGIE's liability is sought by a third party.

15-2 The Client authorizes POOL TECHNOLOGIE to use its name and logo as a commercial reference.

15-3 No Client may mention or use the trademarks, logos, documents or any other intellectual property rights belonging to or enjoyed by POOL TECHNOLOGIE except with the express, written and prior authorization of the latter and solely for the purpose of promoting the resale of the Products under normal conditions in view of its business.

Any use of a trademark, logo or other distinctive signs by the Client is made under its full and complete responsibility in compliance with the graphic charter and legal information concerning the Products, in particular in the event of their presence on a website as well as on any printed material.

Any document, of any kind whatsoever, given or sent to the Client remains the exclusive property of POOL TECHNOLOGIE and, unless expressly agreed beforehand, may not be communicated to third parties for any reason whatsoever.

GENERAL TERMS AND CONDITIONS OF SALE

Article 16 – Personal Data

16-1 The Client is informed and agrees that, in the context of the performance of the Contract, POOL TECHNOLOGIE may store, process, and use the data mentioned in the order for the purpose of processing the order, in accordance with the provisions of applicable regulations regarding the protection of personal data. The Client is invited to visit the following page: <https://pool-technologie.com/politique-de-confidentialite/> to learn more about POOL TECHNOLOGIE's current privacy policy.

16-2 In their relations, each party is solely responsible for the damage caused by any failure to comply with its obligations under the regulations on the protection of personal data.

Article 17 – Extended Producer Responsibility - Unique Identifier(s) (UID)

The unique identifier(s) under which POOL TECHNOLOGIE is registered in accordance with its obligations under the principle of extended producer responsibility are listed below: FR003114_01YHIQ

Article 18 – General Provisions

18-1 If any provision of these Terms and Conditions should be declared inapplicable or invalid for any reason, such invalidity or inapplicability shall not affect the application or validity of the other provisions of these Terms and Conditions.

18-2 The fact that POOL TECHNOLOGIE does not at any given time avail itself of any of the provisions of these General Terms and Conditions cannot in any way be interpreted as a waiver on its part of availing itself of them subsequently in particular the fact of not claiming a late payment.

18-3 In the event of a dispute, the parties agree to consider any electronic document as an original document constituting perfect proof and waive the right to contest this means of proof, except to discuss its authenticity.

18-4 In case of ambiguity between these Terms and Conditions and their English version, the French version shall prevail.

Article 19 – Applicable Law – Disputes

These general terms and conditions of sale and all relations with the Client are subject exclusively to French law, to the exclusion of any international convention.

ANY DISPUTES OR LITIGATION ARISING FROM THE TRANSACTIONS COVERED BY THESE GENERAL TERMS AND CONDITIONS, EVEN IN THE CASE OF MULTIPLE DEFENDANTS OR THIRD-PARTY CLAIMS, WHICH ARE NOT RESOLVED WITHIN THIRTY (30) DAYS OF NOTIFICATION BY THE MOST DILIGENT PARTY, SHALL BE SUBJECT TO THE EXCLUSIVE JURISDICTION OF THE COMMERCIAL COURT OF LYON, WHICH IS EXPRESSLY ACCEPTED BY THE CLIENT.

The Client's possible purchase conditions, as well as the place of signing of the order or contract and, in general, all derogations from the general terms and conditions of sale cannot effect either novation or derogation from this jurisdiction clause, even in the event of a warranty claim or multiple defendants.

By placing an order, the Customer is deemed to have read and accepted these general terms and conditions of sale. Furthermore, the Customer agrees to comply with the installation instructions accompanying the goods, as well as the installation and usage standards in force in the country of destination.



AVADY



+33 1 34 48 16 03



contact@avadypool.com



9 Chaussée Jules César - Building 2 - Gate
221 B 95520 OSNY



www.avadypool.com

